

भारतीय विज्ञान शिक्षा एवं अनुसंधान संस्थान तिरुवनंतपुरम
INDIAN INSTITUTE OF SCIENCE EDUCATION AND RESEARCH
THIRUVANANTHAPURAM

(भारत सरकार, शिक्षा मंत्रालय/ Govt. of India, Ministry of Education)

मरुतामला.पी.ओ/ MARUTHAMALA.P.O, वितुरा/ VITHURA / तिरुवनंतपुरम/ THIRUVANANTHAPURAM – 695 551
केरला/ KERALA, भारत/ INDIA / फोन/ Phone: 0471-2778019 / ईमेल/ email: purchasestores@iisertvm.ac.in
GST 32AAAJI0299R1ZS

तारीख/ Date: 10 Oct 2022

निविदा के लिए आमंत्रण (इ-प्रोक्युमेंट मोड)/ INVITATION TO TENDER (E-Procurement mode only)

No: IISER/PUR/1037/MSS/SP/22-23

नियत तारीख/Due Date: 24 Oct 2022 [3PM]

खोलने की तारीख/Date of Opening: 25 Oct 2022 [3.30PM]

प्रिय महोदय/Dear Sirs,

विषय / SUB: Supply and Installation of two-input-two-output Optical Fibre: reg

- A. The Institute invites Single Cover Tenders from Class I and II local suppliers, as per DPIIT order No. P-45021/2/2017-PP (BE-II) dated 04 Jun 2020, for the following items through the eProcurement System of National Informatics Centre that enables the Tenderers to download the Tender Schedule free of cost and then submit the bids online through Central Public Procurement Portal of Government of India (<https://eprocure.gov.in/eprocure/app>).

Ser	Description of Goods	Quantity
1.	Supply and Installation of two-input-two-output Optical Fibre as per technical specifications and drawing at Annexure 7	One

- B. Please quote only in Indian Rupees as per GFR 2017 amended Rule 161 (iv) and Public Procurement (Preference to make in India) order 2017, with your lowest rate and shortest delivery period as per the following terms. As per Govt of India, Ministry of Commerce and Industry, DPIIT order No. P-45021/2/2017-PP (BE-II) dated 04 Jun 2020 only Class I local Supplier (having local content equal to or more than 50%) and Class II local supplier (having local content more than 20% but less than 50%) are invited for this tender. Non-local supplier (having local content less than or equal to 20%) are not eligible to apply. Local Content means the amount of value added in India which shall, unless otherwise prescribed by the Nodal Ministry, be the total value of the item procured (excluding net domestic indirect taxes) minus the value of imported content in the item (including all customs duties). Class I local supplier / Class-II local supplier are required to indicate percentage of local content and provide self-certification that the item offered meets the local content requirement for 'Class-I local supplier' / 'Class-II local supplier', as the case may be. They shall also give details of the locations(s) at which the local value addition is made. Format for self-certification is given in **Annexure 3** of the tender document. Any non-compliance in this regard, the bid will not be considered in the category.

- C. As per Ministry of Finance, Department of Expenditure order No. F.No./6/18/2019-PPD dated 23 Jul 2020 any bidder from a country which shares a land border with India will be eligible to bid in this tender only if the bidder is registered with the Department of Promotion of Industry and Internal Trade (DPIIT). Format for certificate for the same is given in **Annexure 4** of the tender document. 'Bidder' for the purpose of this order (including the term 'tenderer', 'consultant' 'vendor' or 'service provider' in certain contexts) means any person or firm or company, including any member of a consortium or joint venture (that is an association of several persons, or firms or companies), every artificial juridical person not falling in any of the descriptions of bidders

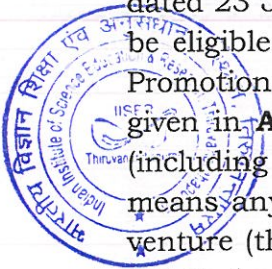

stated hereinbefore, including any agency, branch or office controlled by such person, participating in a procurement process. Bidder from a country which shares a land boarded with India for the purpose of this order means:-

- (i) An entity incorporated, established or registered in such a country; or
- (ii) A subsidiary of an entity incorporated, established or registered in such a country; or
- (iii) An entity substantially controlled through entities incorporated, established or registered in such a country; or
- (iv) An entity whose beneficial owner is situated in such a country; or
- (v) An Indian (or other) agent of such an entity; or
- (vi) A natural person who is a citizen of such a country ; or
- (vii) A consortium or joint venture where any member of the consortium of joint venture falls under any of the above.

- D. **ईएमडी/EMD: Rs. 21,000/- (Rupees Twenty One Thousand only)** स्टेट बैंक संग्रह द्वारा भुगतान करना चाहिए - निविदा संख्या और कंपनी का नाम उल्लेख किया जाना चाहिए। उद्धरण के साथ लेनदेन पर्ची / प्रिंट आउट या ईएमडी मूल्य के बराबर 90 दिनों की वधता में बैंक गारंटी या बोलीदाता के उपक्रम जमा करना चाहिए।/ should be paid through State Bank Collect- Tender No & Company Name must be mentioned in the Remarks column. (<https://www.onlinesbi.com/sbicollect/icollecthome.htm> (State Bank Collect- Accept-Term and Conditions- Proceed-Select State **Kerala**-Select Type of Institution-**Educational Institution**- Select - **IISER Thiruvananthapuram**- Select Payment Category- **Stores and Purchase**) Quotes should accompany a copy of Transaction slip /Print out **OR** Bank guarantee equivalent **OR** Insurance Surety Bond to the EMD value with validity 90 days (should reach before tender due dates). **EMD EXEMPTION:** The bidder seeking EMD exemption, must submit the valid supporting document with the bid. Under MSE category, only manufacturers for goods and Service Providers for Services are eligible for exemption from EMD. Traders are excluded from the purview of this Policy.
- E. **भुगतान/ PAYMENT:** आपूर्ति और स्थापना के बाद 30 दिनों के अंदर **आईआईएसईआरटीवीएम** द्वारा कोई अग्रिम भुगतान नहीं किया जाएगा।/ Within 30 days after supply and installation. **Advance payment will not be made by IISERTVM.**
- F. **वितरण/ Delivery:** विथुरा कैम्पस में वितरित करना है (मुफ्त वितरण)। अगर आयात करें तो स्पष्ट रूप से ब्रेकअप शुल्क के साथ पूर्व-कार्य / एफसीए / सीआईपी शर्तों का उल्लेख करें।/ To be delivered at **Vithura Campus** (Free delivery including unloading charges).
- G. **कर एवं कर्तव्य/ TAXES & DUTIES:** At actuals. Indicate taxes and duties. We are partially exempted for customs duty under 51/96 notification
- H. **छूट/ Discount:** अगर कोई हज़ो सूचित करें।/ Indicate, if any.
- I. **वितरण अनुसूची/Delivery Schedule:** अति आवश्यक है। अपना अनुसूची उल्लिखित करें।/ Required Immediately. Indicate your schedule
- J. **उद्धरण की विधिमान्यता Validity of quote: 90 दिन/90 days**



K. Annexure 3,4,5,6 and 7: should be enclosed with the offer. If not, the bid will be summarily rejected.

Details: Annexure 1: Terms & Conditions, **Annexure 2:** Instructions to Bidder for Online Bid Submission, **Annexure 3:** Declaration of Local Content **Annexure 4:** Certificate by Bidder **Annexure 5 :** Tender Acceptance Letter, **Annexure 6:** Certificate of not being blacklisted **Annexure 7 :** Detailed Specifications **Annexure 8:** Check list of documents required.

भवदीय/ Yours Faithfully

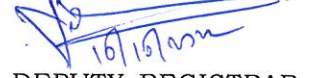

उप कुलसचिव/ DEPUTY REGISTRAR
क्रय / PURCHASE & STORES





ANNEXURE: 1

निविदाकारों के लिए निर्देश (स्वदेशी)/ INSTRUCTION TO TENDERER

1. कर/ अन्य कर्तव्य/ अधिभार निविदा में अलग से दिखाया जाना चाहिए।/ Tax and /or other duties/levies where legally levies and intended to be claimed should be distinctly shown separately in the tender.
2. (a) आपका उद्धरण निविदा खोलने की तारीख से 90 दिनों के लिए मान्य होता है। निश्चित कीमत के साथ के संविदा दर को प्राथमिकता दी जाएगी।/ Your quotation should be valid for a minimum period of 90 days from the date of opening of the Tender. Quotation with firm prices will be preferred.
(b) निविदा के आमंत्रण में संकेतित इकाइयों के अनुसार कीमत उद्धृत करना है। जब निविदा फॉर्म में उल्लिखित इकाइयों के अलावा संविदा दर दिए जाने पर दो इकाइयों के बीच के संबंध प्रस्तुत किया जाना चाहिए।/ Prices are required to be quoted according to the units indicated in the Invitation to Tender. When quotations are given in terms of units other than those specified in the tender form, relationship between the two sets of units must be furnished.
3. (a) तैयार माल से आपूर्ति करने वाले निविदाओं को वरीयता दी जाएगी। वितरण का आधार आईआईएसईआर के साइट पर मुफ्त में है।/ Preference will be given to those tenders offering supplies from ready stocks. The basis of delivery is at IISER site free of cost.
(b) हमारी भुगतान की शर्तें माल की प्राप्ति और स्वीकृति के 30 दिनों के भीतर होगा।/ our payment terms are within 30 days of receipt and acceptance of the item at our site.
4. (a) वस्तुओं के सभी उपलब्ध तकनीकी साहित्य, सूचीपत्र और अन्य आंकड़े प्रस्ताव के साथ प्रस्तुत किया जाना चाहिए।/All available technical literature, catalogues and other data in support of the specifications and details of the items should be furnished along with the offer.
विशेष विवरण/ Specifications: प्रस्तावित भंडार हमारे विवरण के अनुरूप होना चाहिए। अगर विचलन है तो निविदाकार अपने उद्धरण में संकेत दिया जाना चाहिए। निविदाकार भंडार के प्रारूप सूचित करना चाहिए और आवश्यक होने पर संविदा दर के साथ सूचीपत्र, तकनीकी साहित्य और नमूने प्रदान करना चाहिए। आवश्यक होने पर परीक्षण प्रमाण पत्र आपूर्ति के साथ अग्रेषित किया जाना चाहिए। निविदाकार को उपयुक्त कारणों के साथ विनिर्देशों में परिवर्तन का सुझाव दे सकता है।/ Stores offered should strictly conform to our specifications. Deviations, if any should be clearly indicated by the tenderer in their quotation. The tenderer should also indicate the Make/Type number of the stores offered and provide catalogues, technical literature and samples, wherever necessary along with the quotations. Test Certificates wherever necessary should be forwarded along with supplies. Whenever specifically mentioned by us the tenderer could suggest changes to specifications with appropriate reasons for the same.
5. आईआईएसईआर को निम्नतम या किसी भी निविदा को स्वीकार करने के लिए कोई दायित्व नहीं होगा और पूरे या निविदा के किसी हिस्से के स्वीकृति का अधिकार सुरक्षित रखेगा और निविदाकार उद्धृत दरों पर समान की आपूर्ति करना चाहिए।/ IISER shall be under no obligation to accept the lowest or any tender and reserves the right of acceptance of the whole or any part of the tender or portion of the quantity offered and the tenderers shall supply the same at the rates quoted.
6. अगर संवुदा दर में कोई सुधार होने पर इसे प्रमाणित किया जाना चाहिए। सभी राशी शब्दों और आंकड़ों में भी सूचित किया जाना चाहिए। यदि शब्दों और आंकड़ों में उद्धृत राशि के बीच अंतर होने पर शब्दों में उद्धृत राशि प्रबल होगी। संविदा दर में प्रत्येक वस्तु के मूल्य होना चाहिए और कर और कर्तव्यों सहित मूल्य की कुल राशि का स्पष्ट रूप से उल्लेख किया जाना चाहिए।/ Corrections, if any, in the Quotation must be attested. All amounts shall be indicated both in words as well as in figures. Where there is difference between amounts quoted in words and figures, amount quoted in words shall prevail. Quotation must have price for each line item and totaling of the price including taxes and duties should be clearly mentioned.
7. निविदाकार निविदा में अपने बैंकर, कर पंजीकरण, पैन नंबर आदि उल्लिखित करना चाहिए।/ The tenderer should mention the name of his bankers, Tax Registration, PAN number etc in the tender.
8. निविदा पर हस्ताक्षर करने वाले व्यक्ति बुलाने पर उपस्थित होना चाहिए। The authority of the person signing the tender, if called for, should be produced.
9. IISER being a Govt of India Educational and Research Institute, is exempted from payment of Customs Duty under Notification No. 51/96- Customs dated 23rd July 2009.
10. आपूर्ति की गई भंडार आपूर्ति, स्थापना और कमीशन की तारीख से 1 वर्ष वारंटी में होगा।/ The stores supplied should be covered with minimum of 1 year warranty from the date of supply, installation and commissioning, if not stated otherwise in tender specification.
11. निविदा के आमंत्रण में उल्लिखित के अनुसार धन जमा / बोली सुरक्षा जमा उद्धरण के साथ जमा किया जाना चाहिए। ईएमडी भारतीय विज्ञान शिक्षा एवं अनुसंधान संस्थान तिरुवनंतपुरम के पक्ष में 90 दिनों के लिए मान्य होगा।/ Earnest Money Deposit/ Bid Security should be submitted along with your quote as mentioned in Invitation for Tender. EMD should be in favour of Indian Institute of Science Education and Research Thiruvananthapuram valid for 90 days.
12. IISER-TVM comply with order No. P-45021/2/2017-PP(BE-11) dated 04 Jun 2020 (Public Procurement/ Preference to Make in India) and its order 2017 revision.
13. LD Clause: LD may be imposed @ 0.5% per week after stipulated delivery period.
14. Award of Contract (AOC) would be issued to the technically qualified lowest bidder.
15. Tender due date would be auto-extended upon non-receipt of sufficient number of bids.
16. If the bidder withdraws or modifies or amends its tender or impairs or derogates from its bid during the bid validity period or if awarded the contract and fails to sign the contract or fails to furnish order acceptance or performance security before the deadline defined by the Institute, they will be suspended for the period of time as decided by the administrative competent authority of IISER Thiruvananthapuram from being eligible to submit bids for contracts floated by the Institute in accordance with GoI MOF Office memorandum NO. F/9/4/2020-PPD dated 12 Nov 2020 and GFR

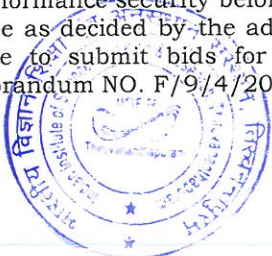

ANNEXUE: 2
Instructions To Bidder for Online Bid Submission

The bidders are required to submit soft copies of their bids electronically on the CPP Portal, using valid Digital Signature Certificates. The instructions given below are meant to assist the bidders in registering on the CPP Portal, prepare their bids in accordance with the requirements and submitting their bids online on the CPP Portal.

More information useful for submitting online bids on the CPP Portal may be obtained at: <https://eprocure.gov.in/eprocure/app>.

REGISTRATION

- 1) Bidders are required to enroll on the e-Procurement module of the Central Public Procurement Portal (URL: <https://eprocure.gov.in/eprocure/app>) by clicking on the link "Online bidder Enrollment" on the CPP Portal which is free of charge.
- 2) As part of the enrolment process, the bidders will be required to choose a unique username and assign a password for their accounts.
- 3) Bidders are advised to register their valid email address and mobile numbers as part of the registration process. These would be used for any communication from the CPP Portal.
- 4) Upon enrolment, the bidders will be required to register their valid Digital Signature Certificate (Class III Certificates with signing key usage) issued by any Certifying Authority recognized by CCA India (e.g. Sify / nCode / eMudhra etc.), with their profile.
- 5) Only one valid DSC should be registered by a bidder. Please note that the bidders are responsible to ensure that they do not lend their DSC's to others which may lead to misuse.
- 6) Bidder then logs in to the site through the secured log-in by entering their user ID / password and the password of the DSC / e-Token.

SEARCHING FOR TENDER DOCUMENTS

- 1) There are various search options built in the CPP Portal, to facilitate bidders to search active tenders by several parameters. These parameters could include Tender ID, Organization Name, Location, Date, Value, etc. There is also an option of advanced search for tenders, wherein the bidders may combine a number of search parameters such as Organization Name, Form of Contract, Location, Date, Other keywords etc. to search for a tender published on the CPP Portal.
- 2) Once the bidders have selected the tenders they are interested in, they may download the required documents / tender schedules. These tenders can be moved to the respective 'My Tenders' folder. This would enable the CPP Portal to intimate the bidders through SMS / email in case there is any corrigendum issued to the tender document.
- 3) The bidder should make a note of the unique Tender ID assigned to each tender, in case they want to obtain any clarification / help from the Helpdesk.

PREPARATION OF BIDS

- 1) Bidder should take into account any corrigendum published on the tender document before submitting their bids.
- 2) Please go through the tender advertisement and the tender document carefully to understand the documents required to be submitted as part of the bid. Please note the number of covers in which the bid documents have to be submitted, the number of documents - including the names and content of each of the document that need to be submitted. Any deviations from these may lead to rejection of the bid.
- 3) Bidder, in advance, should get ready the bid documents to be submitted as indicated in the tender document / schedule and generally, they can be in PDF / XLS / RAR / DWF/JPG formats. Bid documents may be scanned with 100 dpi with black and white option which helps in reducing size of the scanned document.
- 4) To avoid the time and effort required in uploading the same set of standard documents which are required to be submitted as a part of every bid, a provision of uploading such standard documents (e.g. PAN card copy, annual reports, auditor certificates etc.) has been provided to the bidders. Bidders can use "My Space" or "Other Important Documents" area available to them to upload such documents. These documents may be directly submitted from the "My Space" area while submitting a bid, and need not be uploaded again and again. This will lead to a reduction in the time required for bid submission process.

Note: My Documents space is only a repository given to the Bidders to ease the uploading process. If Bidder has uploaded his Documents in My Documents space, this does not automatically ensure these Documents being part of Technical Bid.

SUBMISSION OF BIDS

- ★ 1) Bidder should log into the site well in advance for bid submission so that they can upload the bid in time i.e. on or before the bid submission time. Bidder will be responsible for any delay due to other issues.
- 2) The bidder has to digitally sign and upload the required bid documents one by one as indicated in the tender document.

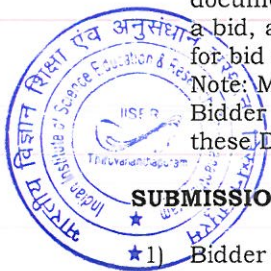

- 3) Bidder has to select the payment option as "offline" to pay the tender fee / EMD as applicable and enter details of the instrument.
- 4) Bidder should prepare the EMD as per the instructions specified in the tender document. The original should be posted/couriered/given in person to the concerned official, latest by the last date of bid submission or as specified in the tender documents. The details of the DD/any other accepted instrument, physically sent, should tally with the details available in the scanned copy and the data entered during bid submission time. Otherwise the uploaded bid will be rejected.
- 5) Bidders are requested to note that they should necessarily submit their technical & financial bids in PDF format only and no other format is acceptable. If the price bid has been given as a standard BoQ format with the tender document, then the same is to be downloaded and to be filled by all the bidders. Bidders are required to download the BoQ file, open it and complete the white coloured (unprotected) cells with their respective financial quotes and other details (such as name of the bidder). No other cells should be changed. Once the details have been completed, the bidder should save it and submit it online, without changing the filename. If the BoQ file is found to be modified by the bidder, the bid will be rejected.
- 6) The server time (which is displayed on the bidders' dashboard) will be considered as the standard time for referencing the deadlines for submission of the bids by the bidders, opening of bids etc. The bidders should follow this time during bid submission.
- 7) All the documents being submitted by the bidders would be encrypted using PKI encryption techniques to ensure the secrecy of the data. The data entered cannot be viewed by unauthorized persons until the time of bid opening. The confidentiality of the bids is maintained using the secured Socket Layer 128 bit encryption technology. Data storage encryption of sensitive fields is done. Any bid document that is uploaded to the server is subjected to symmetric encryption using a system generated symmetric key. Further this key is subjected to asymmetric encryption using buyers/bid opener's public keys. Overall, the uploaded tender documents become readable only after the tender opening by the authorized bid openers.
- 8) The uploaded tender documents become readable only after the tender opening by the authorized bid openers.
- 9) Upon the successful and timely submission of bids (i.e. after Clicking "Freeze Bid Submission" in the portal), the portal will give a successful bid submission message & a bid summary will be displayed with the bid no. and the date & time of submission of the bid with all other relevant details.
- 10) The bid summary has to be printed and kept as an acknowledgement of the submission of the bid. This acknowledgement may be used as an entry pass for any bid opening meetings.

ASSISTANCE TO BIDDERS

- 1) Any queries relating to the tender document and the terms and conditions contained therein should be addressed to the Tender Inviting Authority for a tender or the relevant contact person indicated in the tender.
 - 2) Any queries relating to the process of online bid submission or queries relating to CPP Portal in general may be directed to the 24x7 CPP Portal Helpdesk.
-



Declaration of Local Content**(ON COMPANY LETTER HEAD)**

(In case the procurement value is less than or equal to Rs. 10 Crores declaration to be given in Bidder's/Company's letter head and if more than Rs. 10 Crores declaration to be issued from the statutory auditor or cost auditor of the company (in case of companies from a practicing cost accountant or practicing chartered accountant (in respect of suppliers other than companies)

To,
The Director,
Indian Institute of Science Education and Research Thiruvananthapuram,
Maruthamala P.O., Vithura, Thiruvananthapuram, Kerala, India – 695551

Subject: Declaration of local content and compliance of Public Procurement (Preference to Make in India) Order 2017 and its amendments regarding.

Sl No	Name of the goods/service/works	Category of the supplier (Class I / II / III)	Currency (must be in INR)	Local Content (%)	Location at which value addition is made	Country of Origin	Comply to the above referred rule (Yes / No)
1							

- "Local Content" means the amount of value added in India which shall, be the total value of the item being offered (excluding net domestic indirect taxes) minus the value of the imported content in the item (including all customs duties) as a proportion of the total value, in percent.
- False declarations will be in breach of Code of Integrity under Rule 175(1)(i)(h) of the General Financial Rules for which a bidder or its successors can be debarred for up to two years as per Rule 151(iii) of the General Financial Rules along with such other actions permissible under law.

Date:

Place:

Signature with Date and Stamp of the Bidder



CERTIFICATE BY THE BIDDER (FOR TENDERS)
(ON COMPANY LETTER HEAD)

I have read the clause regarding restrictions on procurement from a bidder of a country which shares a land border with India. I certify that this bidder is not from such a company or, / if from such a country, has been registered with the Competent Authority (copy of the Registration Certificate enclosed). I hereby certify that this bidder fulfills all requirements in this regard and is eligible to be considered.

Date:

Place:

Signature with Date and Stamp of the Bidder



TENDER ACCEPTANCE LETTER
(To be given on Company Letter Head)

To,
**The Director, Indian Institute of Science Education and Research –
Thiruvananthapuram,
Maruthamala P.O, Vithura, Thiruvananthapuram, Kerala -695551, India.**

Date:

Sub: Acceptance of Terms & Conditions of Tender.

Tender Reference No: _____

Name of Tender / Work: - _____

Dear Sir,

1. I / We have downloaded / obtained the tender document(s) for the above mentioned 'Tender/Work' from the web site(s) namely: _____ as per your advertisement, given in the above mentioned website(s).
2. I / We hereby certify that I / we have read the entire terms and conditions of the tender documents from Page No. _____ to _____ (including all documents like annexure(s), schedule(s), etc .), which form part of the contract agreement and I / we shall abide hereby by the terms / conditions / clauses contained therein.
3. The corrigendum(s) issued from time to time by your department/ organization too have also been taken into consideration, while submitting this acceptance letter.
4. I / We hereby unconditionally accept the tender conditions of above mentioned tender document(s) / corrigendum(s) in its totality / entirety.
5. I / We do hereby declare that our Firm has not been blacklisted/ debarred by any Govt. Department/Public sector undertaking.
6. I / We certify that all information furnished by the our Firm is true & correct and in the event that the information is found to be incorrect/untrue or found violated, then your department/ organization shall without giving any notice or reason therefore or summarily reject the bid or terminate the contract, without giving any notice or reason therefore or summarily reject the bid or terminate the contract, without prejudice to any other rights or remedy including the forfeiture of the full said earnest money deposit absolutely.
7. I / We declare the following information provided are correct to the best of my knowledge:

1	Name and Address of the bidder	
2	Manufacturer / Dealer / Agent	
3	Contact Person	
4	Phone	
5	Email	
6	Mobile Number	
7	GST No	
8	PAN No	
9	UTR No / DU No (in case of online transfer of Tender Fee) (if any)	
10	UTR No / DU No (in case of online transfer of EMD)	
11	Warranty, if any	
12	Delivery period	
13	Payment terms	
14	PO to be placed in favour of	

Yours Faithfully,

Date:

Place:

**Signature with Date and Stamp of the Bidder**

CERTIFICATE
(ON COMPANY LETTER HEAD)

I hereby certify that we M/s

_____ (name and address of the firm) is neither blacklisted by any Central/ State Government / Public Undertaking/ Institute nor is any criminal case registered / pending against the firm or its owner / partners anywhere in India.

I also certify that the above information is true and correct in every aspect and in any case at a later date it is found that any details provided above are incorrect, any contract given to the above firm may be summarily terminated and the firm blacklisted.

Date:

Place:

Signature with Date and Stamp of the Bidder



TECHNICAL SPECIFICATIONS

Technical Specification:

- Total length $\geq 2.0\text{m}$ (2000mm)
- Two-input-two-output (shown in attached figure).
- Tips (of Input-Fibre #1 & Input-Fibre #2): Standard circular cross-section (adaptable to our existing tuneable pulse (OPO) laser output (Part No.: SpitLight OPO Evo 150-532, InnoLas Laser GmbH, Germany))
- Tips (of Output-Fibre #1 & Output-Fibre #2): Rectangular cross-section (shown in the attached figure)
- Operating wavelength: 650-1050nm (at least)
- Total no. of fibre strains ≥ 2000
- Other details: As per given in the attached figure

19/1/20



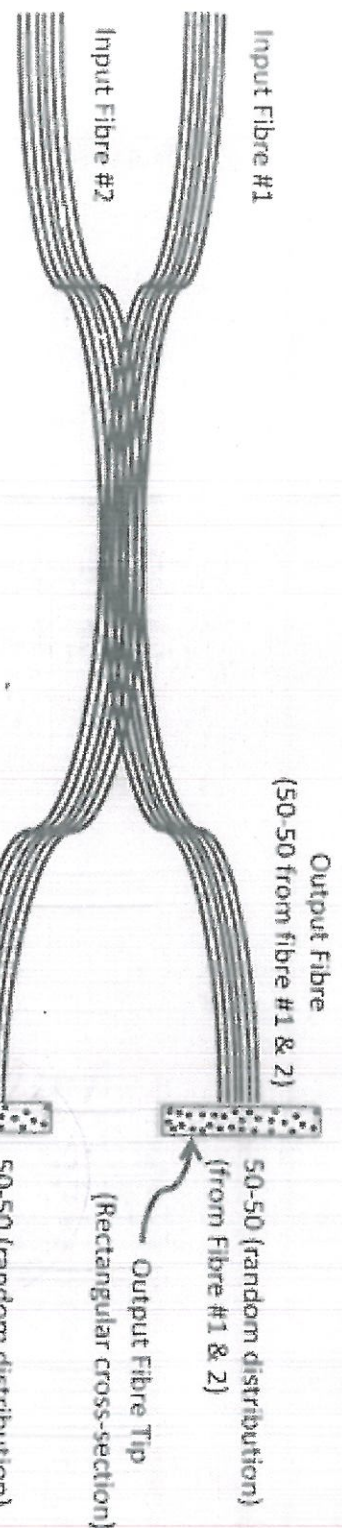

1. Ferrule 1 (Material: St. Steel, 2 units)
2. Fused End (Silica Tube, 2 units)
3. Ferrule 2 (Material: Aluminum, 2 units)
4. Screw M3 (material: St. Steel)
5. Splitter (Material: St. Steel, 1 unit)
6. Protection Tube (Material: St Steel)
7. Protection Tube (Material: St Steel)
8. Lable

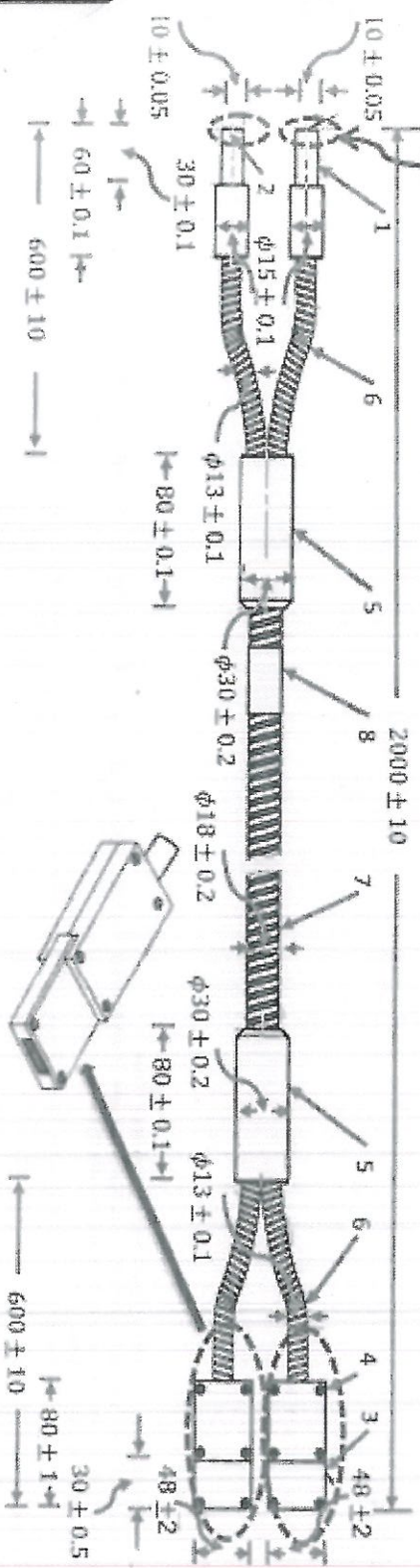
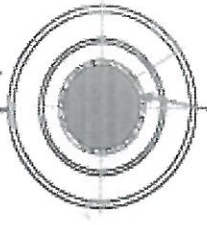

Handwritten signature



CHECK LIST OF DOCUMENT REQUIRED

<u>Ser</u>	<u>List of documents required</u>	<u>Enclosed Yes / No</u>
1.	Self- Certification of local content as per Annexure 3 of the tender document	
2.	Certificate by the bidder as per Annexure 4 of the tender document	
3.	Tender Acceptance Letter as per Annexure 5 of the tender document	
4.	Certificate by the bidder as per Annexure 6 of the tender document	
5.	Technical Compliance statement with tender specifications	
6.	EMD Details	
7.	Brochure/ Catalogue/ Datasheet	
8.	BoQ	
9.	Statutory Registration Certificates	
10.	Previous purchase orders (if any)	
11.	Tender document duly signed on all pages along with bidders seal.	
12.	Other documents pertaining to technical aspects	
13.	Any other document as provided in technical specifications	



